

Preferred Pack[®]

SIDE BELT ADJUSTABLE CARTON SEALERS • MODEL CT-50*

The New Industry Standard for Quality and Reliability

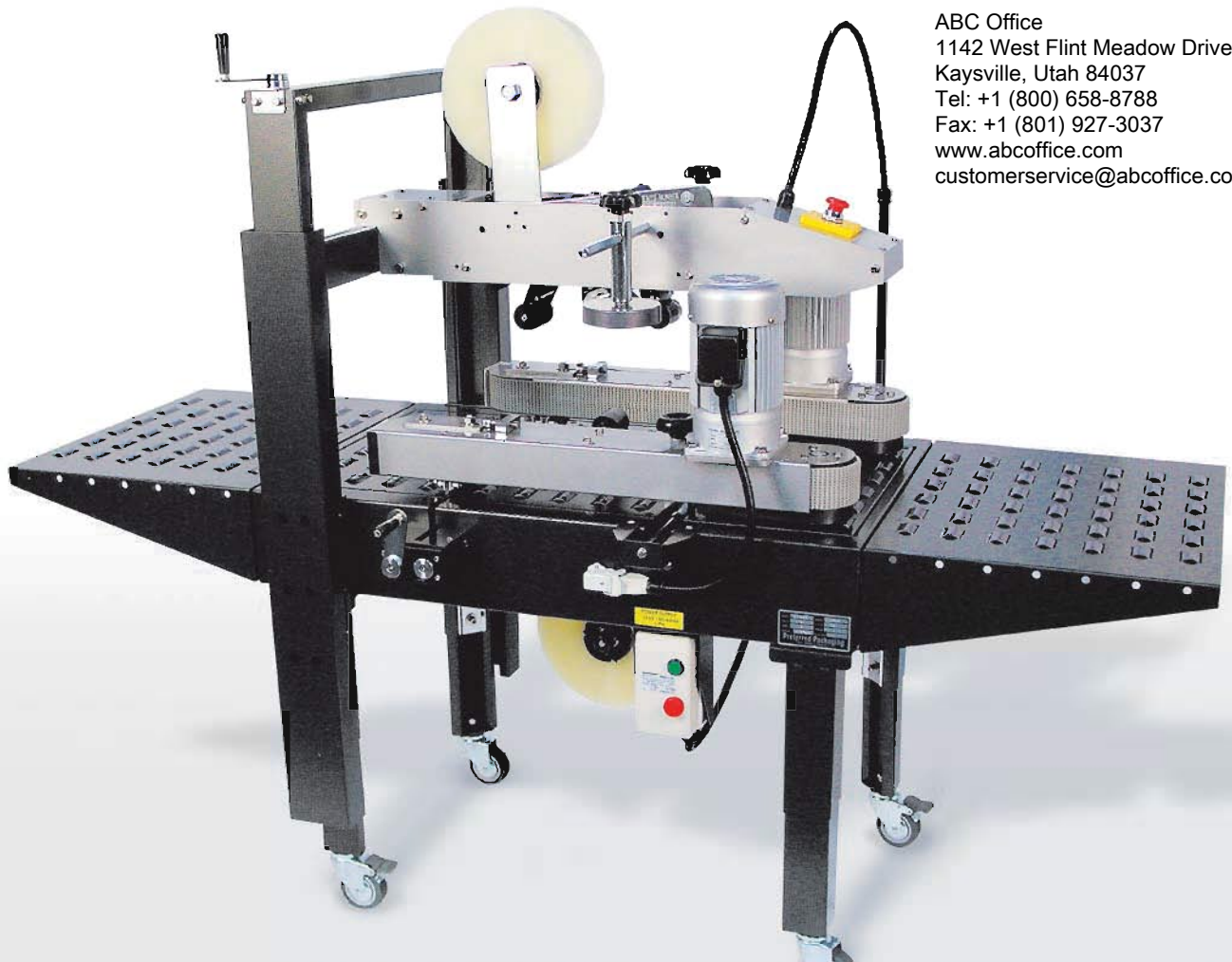

ABC Office
1142 West Flint Meadow Drive
Kaysville, Utah 84037
Tel: +1 (800) 658-8788
Fax: +1 (801) 927-3037
www.abcoffice.com
customerservice@abcoffice.com

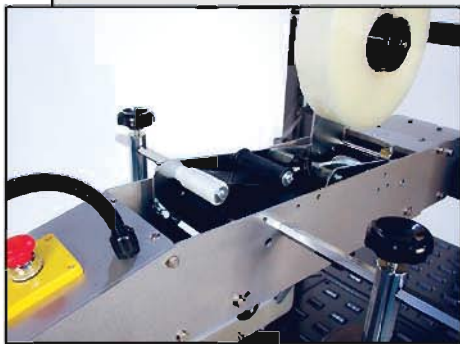

Patented "Easy Thread" Tape Design With Adjustable Box Side Guides.

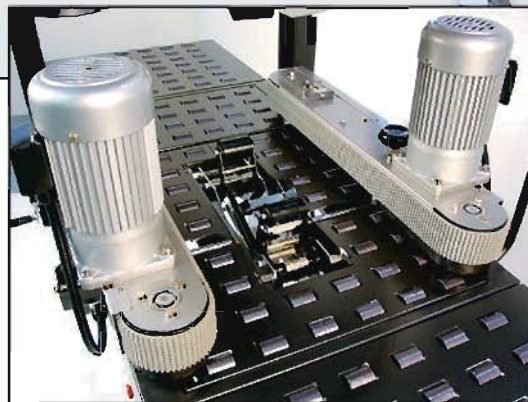

Heavy Duty Dual Side Drive Belts For Positive Grip Pressure.

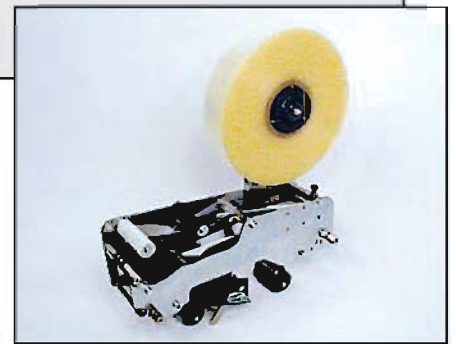

This American Designed Tape Head Features A Patented "Floating Crowned Roller" To Keep Bottom Tape Standing Tall.

Semi-Automatic Uniform Carton Sealer with Easy Manual Carton Size Adjustment. Side Drive Belt Design. Featuring Our New Patented Tape Head with "Easy Thread Design." Machine Comes Complete with Adjustable Height Legs, Power Cord and Plug.

** Shown with Optional Infeed and Discharge Roller Conveyor & Casters.*

CT-50 CARTON SEALER

The operator simply folds the top flaps of the corrugated carton and feeds it into the machine. The CT-50 applies a single tape strip to both the top and bottom of the case simultaneously. This two belt drive design is a heavy duty versatile machine designed for dependable performance and easy operation. The CT-50 can be easily adjusted in only seconds to process a different size carton. Excellent for low profile, small, lightweight boxes.

STANDARD FEATURES:

- "Patented" Tape Head with "Easy Thread" Design
- Interchangeable Tape Heads
- Side Pressure Rollers to Close Box Top
- 2 Side Drive Belts - Positive Feed
- Heavy Duty Locking Casters
- Fully Adjustable Legs

OPTIONAL FEATURES:

- 3" (72mm) Tape Heads
- Infeed Conveyor
- Exit Conveyor
- Stainless Steel Frame
- Caster

SPECIFICATIONS:

CARTON SIZE:	LENGTH: 6" min. to Infinite
	WIDTH: 4.5" min. to 18.5" max.
	HEIGHT: 4" min. to 19.5" max.
MACHINE SIZE:	36"L x 27"W x 53"H
MACHINE SPEED:	75ft./min. up to 2000 cartons per hour. Production rate depends on carton size and operator dexterity
ELECTRICAL:	110 Volt, 1 Phase, 10 Amp
WEIGHT:	320 lbs. Shipping Weight: 370 lbs.
MAX BOX WEIGHT:	65lbs.
TAPE HEAD SPECS:	2" (48mm) Wide - 1,000 yard or 1,500 yard rolls.
WARRANTY:	1 Year on all parts

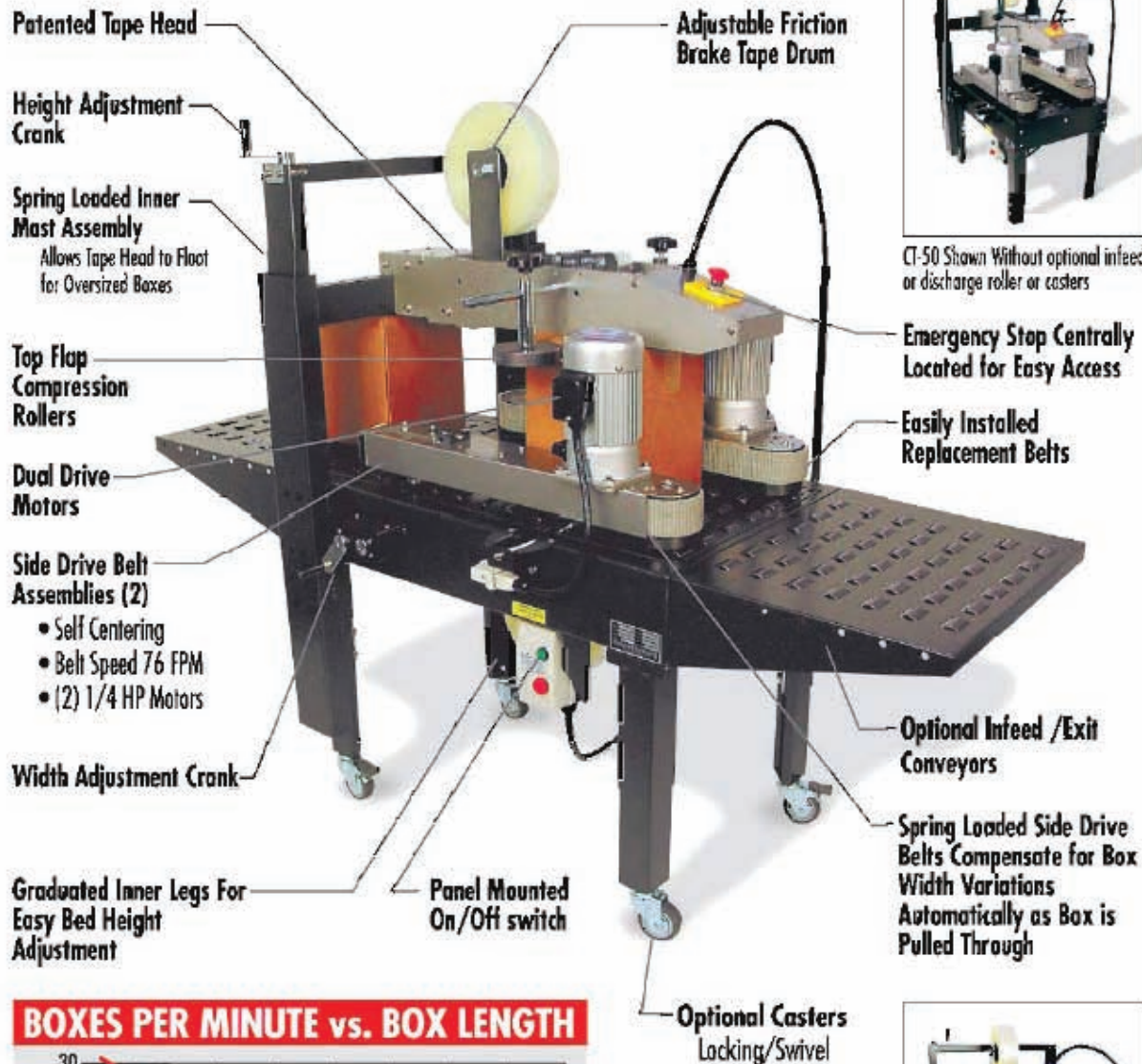
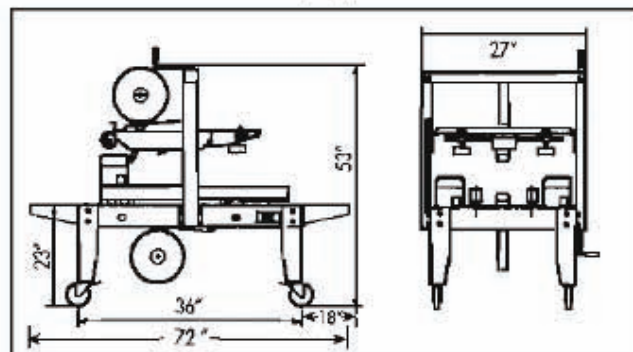

CT-50 Shown Without optional infeed or discharge roller or casters

Emergency Stop Centrally Located for Easy Access

Easily Installed Replacement Belts

Optional Infeed /Exit Conveyors

Spring Loaded Side Drive Belts Compensate for Box Width Variations Automatically as Box is Pulled Through

Optional Casters Locking/Swivel

BOXES PER MINUTE vs. BOX LENGTH

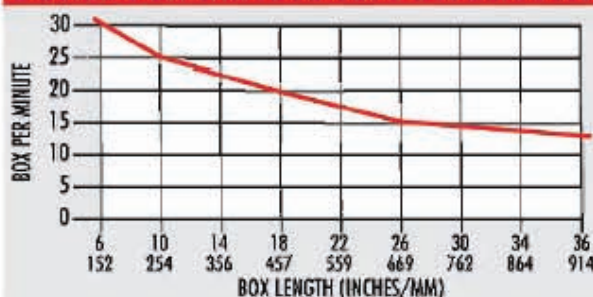

Model CT-75 uses 3" (72mm) Tape Heads